

Article number: 207321M81010ST
Description: E+G Shoulder screw
GN 732.1-M8-10-10-ST

Measures

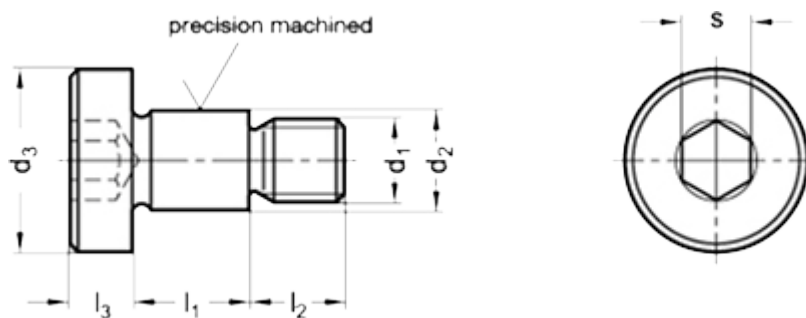

Application example



d1	= M 8
d2	= 10 -0.05/-0.08
d3	= 16
$l_1 +0.20/+0.13$	= 10
l_2	= 11
l_3	= 5
s	= 5
Weight in (g)	= 15